

Subject to change. | Änderungen vorbehalten. | Sous réserve de modifications.

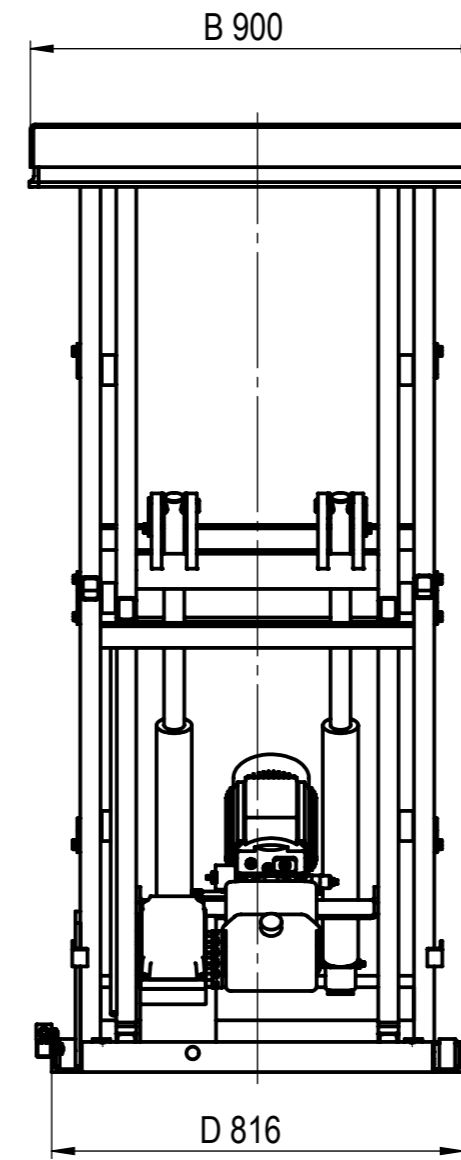

HTP ERGONOMIZER

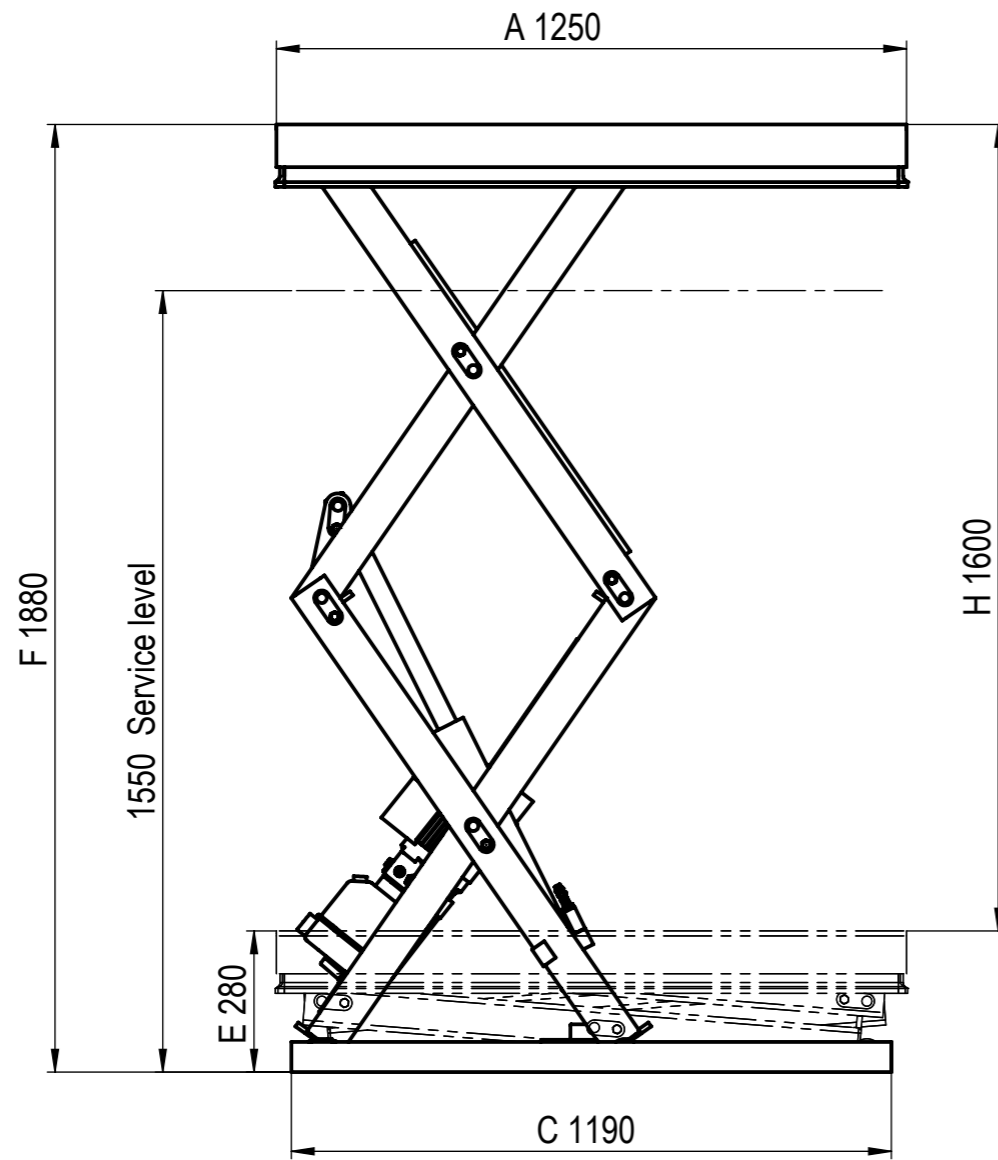

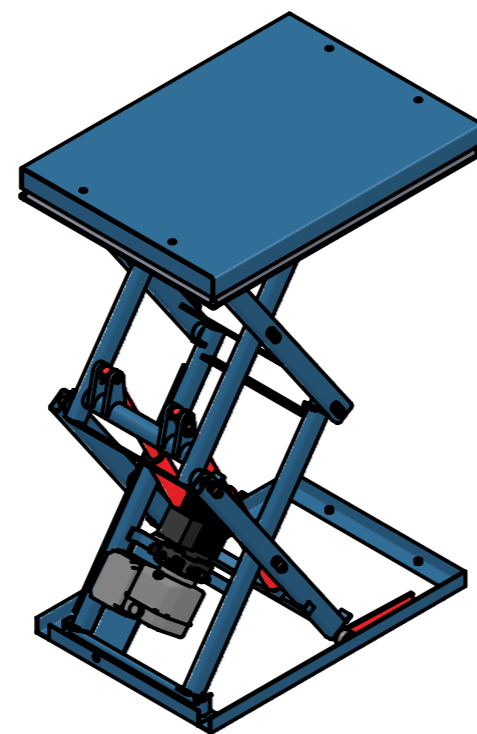

Capacity / Tragfähigkeit / Capacité (Full surface load / Flächenlast / Pleine charge de surface)	500	[kg]
Max Lifting / Max Hub / Hauteur de Levage max	1600	[mm]
Lifting Time / Hubzeit / Temps de course	30	[sek]
Required Power / Motorleistung / Puissance Moteur	1,5	[kW]
Power Supply / Stromversorgung / Tension d'alimentation	3x400V 50Hz	
Lifting Category / Hubkategorie / Catégorie de Levage	2	
Class of Protection / Schutzklasse / Classe de protection	IP54	
Color / Farbe / Couleur	RAL 5015	

		Part name			Quantity:	
		HTPD 5 - 1600 1250x900				
		Drawing nr			Weight:	
		0176.17 00-00 HTPD-5-1600 -K11			254kg	
	Dimension in	Sheet	Size	Scale	Index	Date
	mm	1 / 2	A3	1:15	MK	2017-09-28
General tolerances for nominal dimension without specified tolerance: IT 13 The Information Contained In This Drawing Is The Sole Property Of Columbus McKinnon Corporation. Any Reproduction In Part Or As A Whole Without The Written Permission Of Columbus McKinnon Corporation Is Prohibited.						

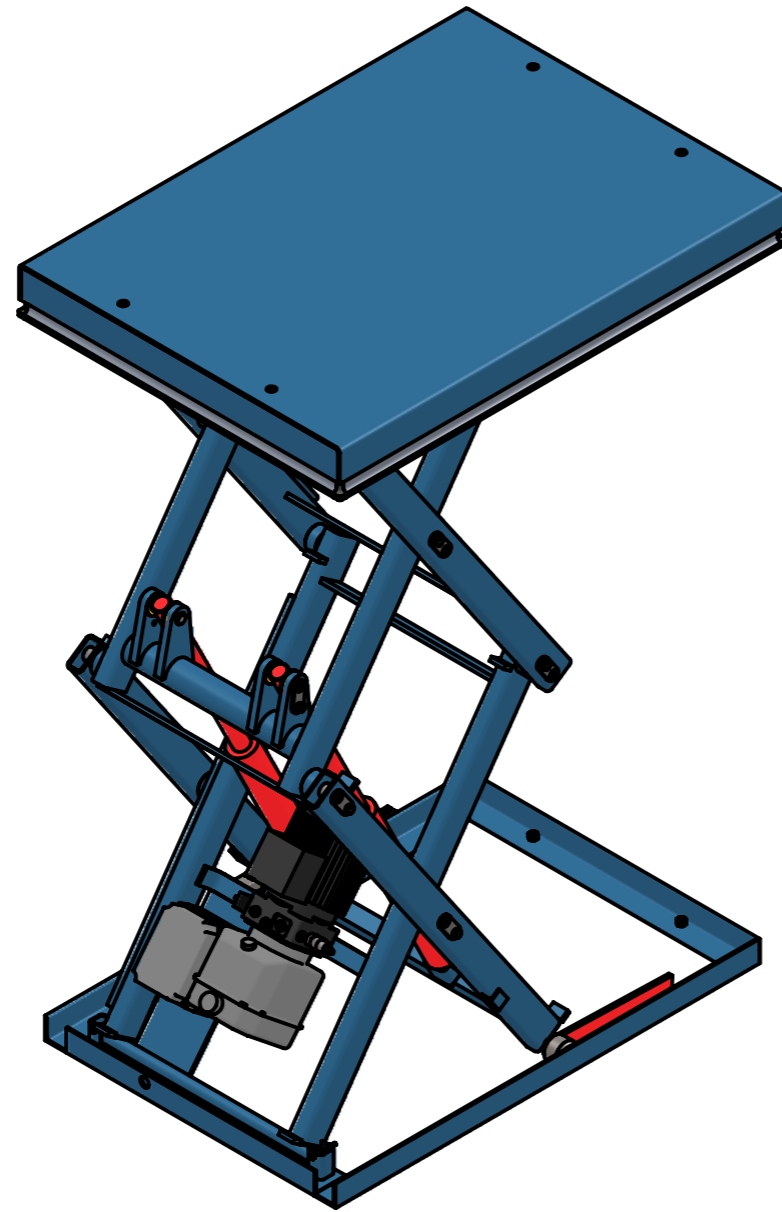
HTP ERGONOMIZER



Subject to change. | Änderungen vorbehalten. | Sous réserve de modifications.

		Part name				Quantity:	
		HTPD 5 - 1600 1250x900					
		Drawing nr				Weight:	
		0176.17 00-00 HTPD-5-1600 -K11				254kg	
Dimension in	Sheet	Size	Scale	Index	Date		
mm	2 / 2	A3	1:15	MK	2017-09-28		
<small>General tolerances for nominal dimension without specified tolerance: IT 13 The Information Contained In This Drawing Is The Sole Property Of Columbus Mckinnon Corporation. Any Reproduction In Part Or As A Wholewithout The Written Permission Of Columbus Mckinnon Corporation Is Prohibited.</small>							